

# Evolution Wine Wall 30"

Spec Sheet for (WW-301-2C) 12-bottle wine rack.

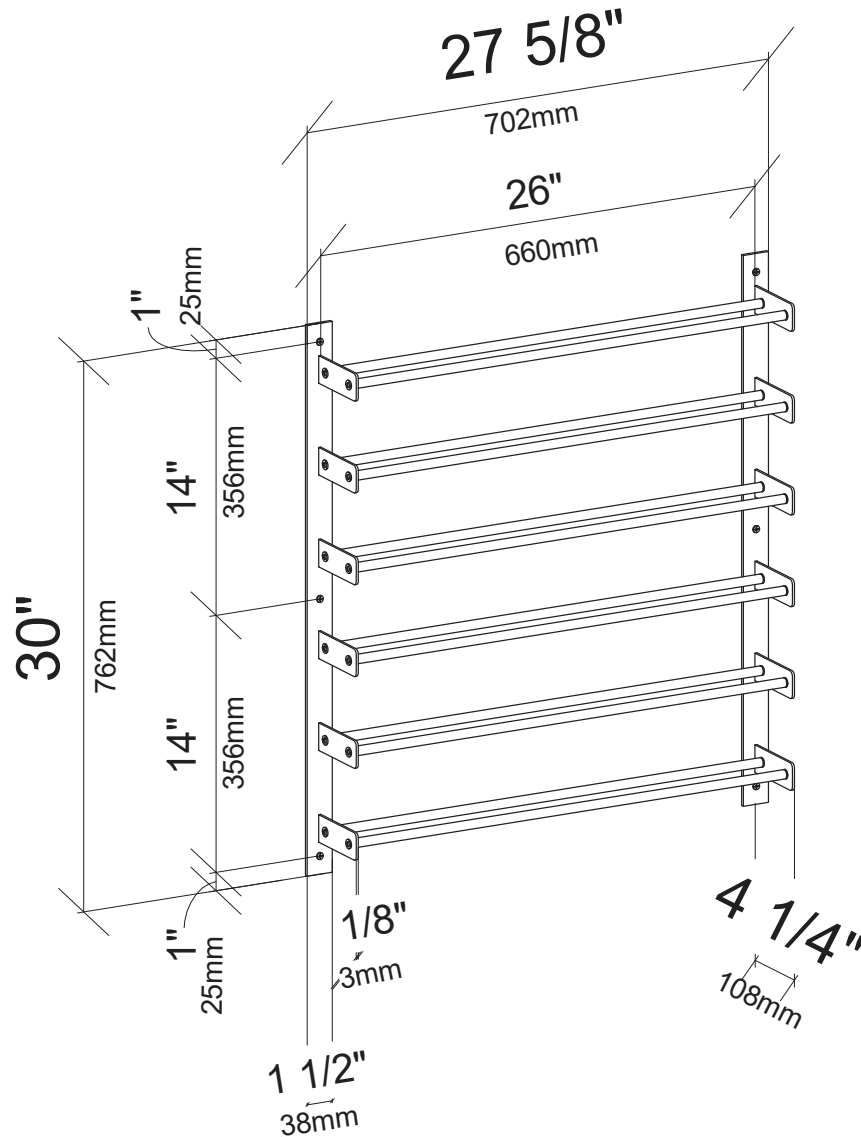

VINTAGEVIEW®  
MOVING WINE STORAGE FORWARD

4690 Joliet St, Denver, CO 80239 | phone: 866.650.1500 | fax: 866.650.1501 | [VintageView.com](http://VintageView.com)

For product warranty information, please visit [vintageview.com/warranty](http://vintageview.com/warranty)