

Armacost RibbonFlex home Tunable White LED Tape Light Kit

SAFETY INFORMATION

- **DANGER:** Risk of eye damage. Do not stare directly at the LED chips of this LED strip.
- **CAUTION:** Do not power LED tape while coiled on reel.
- **IMPORTANT:** Always observe polarity for 24-volt connections, positive (+) to positive and negative (-) to negative.
- **IMPORTANT:** Do not install Class 2 low voltage wiring in the same runs as AC main power. If AC and low voltage wires cross, keep them at 90-degree angles. Use only insulated staples, plastic ties, or wire support clips to secure cords and wires.
- **NOTICE:** LED flexible tape lighting rating: 24VDC 1.5A.
- Only use the 24-volt LED lighting power supply which has been provided with this kit.
- Do not bend, crush or pull the cable. Protect from sharp edges, oil and heat.
- For indoor/dry location use only.
- Ensure the connectors are securely fastened before operating the tape.
- Electrical waste should not be disposed of with household waste. Please recycle where facilities exist.

Two-year limited warranty

WHAT IS COVERED

The manufacturer warrants this fixture to be free from defects in materials and workmanship for a period of two (2) years from date of purchase. This warranty applies only to the original consumer purchaser and only to products used in normal use and service. If this product is found to be defective, the manufacturer's only obligation, and your exclusive remedy, is the repair or replacement of the product at the manufacturer's discretion, provided that the product has not been damaged through misuse, abuse, accident, modifications, alteration, neglect, or mishandling. This warranty shall not apply to any product that is found to have been improperly installed, set-up, or used in any way not in accordance with the instructions supplied with the product. This warranty shall not apply to a failure of the product as a result of an accident, misuse, abuse, negligence, alteration, faulty installation, or any other failure not relating to faulty material or workmanship. This warranty shall not apply to the finish on any portion of the product, such as surface and/or weathering, as this is considered normal wear and tear.

WHAT IS NOT COVERED

The manufacturer does not warrant and specifically disclaims any warranty, whether expressed or implied, of fitness for a particular purpose, other than the warranty contained herein. The manufacturer specifically disclaims any liability and shall not be liable for any consequential or incidental loss or damage, including but not limited to any labor/ expense costs involved in the replacement or repair of said product.

Contact customer support at 410-354-6000, support@armacostlighting.com, or visit armacostlighting.com/support.

Installation considerations

- Where will you locate your power supply?
- How will you run and conceal the wires to your LED tape lighting?
- What is the best mounting position for the LED tape light to achieve your desired effect?
- See the section titled "Mounting options" for cabinet lighting placement tips.

PACKAGE CONTENTS

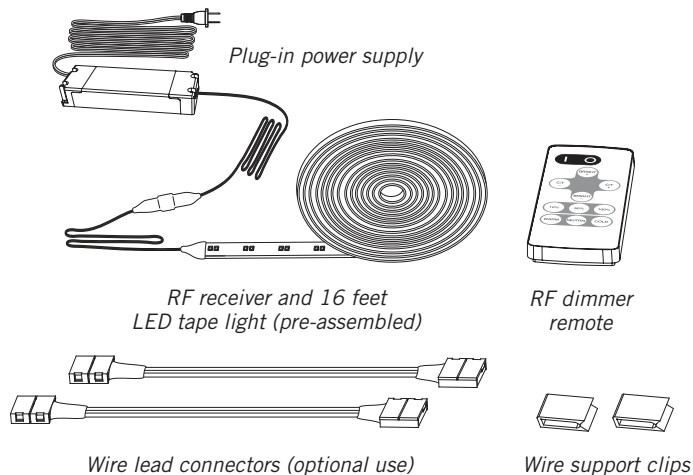

INSTALLATION

Cutting the tape light (optional)

- To use the included connectors, cut the LED tape with scissors in the center of a copper pad (position A) as shown, or attach the connector to the copper pad found at the end of the tape.
- The tape can also be cut at silver solder joints (position B), but this cut point should be used for soldered connections only.

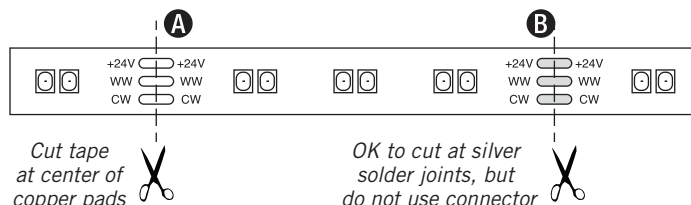

- Use a wire lead connector to make turns and go around corners. They can also be spliced and extended for gaps of any size. 18-20 AWG wire is recommended for custom lengths (not included).

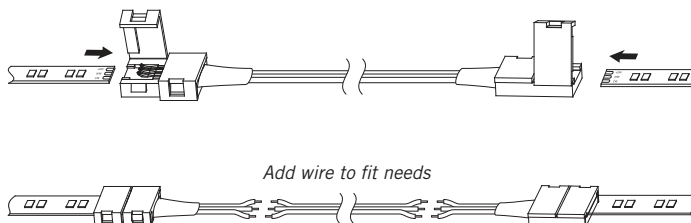

- **IMPORTANT:** Make sure to observe polarity when making connections, +24V to +24V, WW to WW and CW to CW. Check to see that the wire colors and the polarity markings printed on the tape line up.

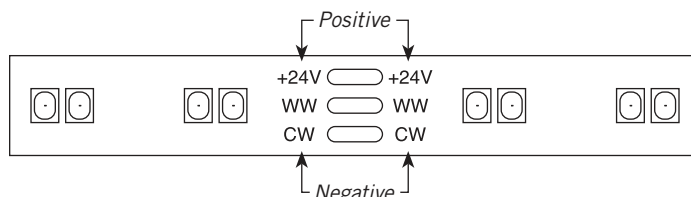

NOTE: Be sure all 24-volt connections are secure and protected from electrical shorting. Options include electrical tape, small wire nuts, crimp connectors, etc.

How to use included connectors

- The wire lead connectors are used to join two sections of LED tape.
- Open the lid of the connector opposite the wire.
- Peel about 1/4 inch of the paper from the LED strip adhesive backing at the connection point.
- Use a gentle side-to-side motion to slide the strip into the connector, making sure the tape slides under the internal connector contact points.
- Perform a power test to be sure the connection is secure. If the LEDs flicker or do not light, repeat the steps in this guide.

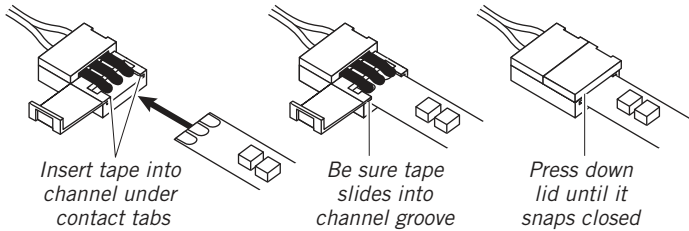

Installing the LED strip

- Working from one end to the other, remove the paper backing protecting the adhesive and firmly press the LED tape down with your fingers or a clean cloth, taking care not to press on the individual LEDs.
- Support and secure the power cables leading to the tape light with the included wire support clips.
- **NOTE:** Although the LED tape can be installed in curved and irregular spaces, avoid sharp bends or bending on the solder joints as you could damage the LED tape light. If an LED is inadvertently damaged and fails to light, the remaining LEDs will continue to operate.

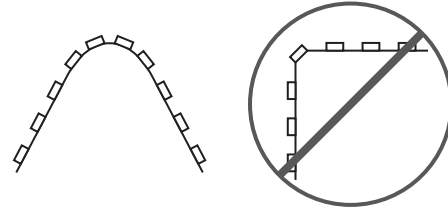

Soldering the LED tape (optional)

- Soldering is another method for joining wires to the tape light and joining sections of tape light directly together.

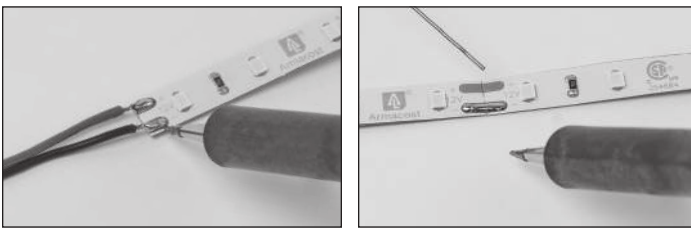

Wire Lead Connection

Splice Connection

Preparing the assembly location

- Power the LED tape lighting and temporarily hold or tape into position with painter's tape or masking tape – do not remove the adhesive paper backing.

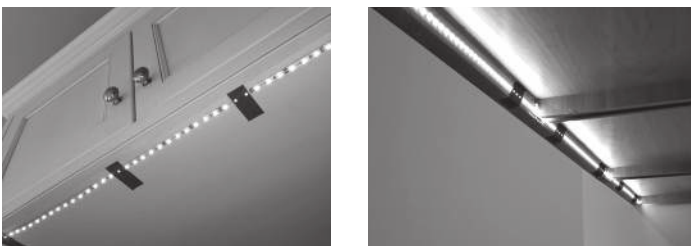

- Adjust the lighting to various angles and positions to get the desired level of illumination and lighting appearance. If the LEDs create undesirable light spots on walls, or reflections, reposition the tape light strip farther away from surfaces or try a different mounting angle.
- Once you have determined your final mounting position, remove any dirt and dust present where the tape will be applied. Mounting surfaces should be clean, completely dry, and as dust-free as possible. For best results, install when temperatures are above 60°F (15°C). When installing on painted surfaces, paint should be fully cured based on manufacturer's cure time.

Installing the power supply

- **IMPORTANT:** Do not power the LED tape while on the reel, as the LEDs will overheat.
- Connect the AC power cord to a live outlet.
- If connected to a switched outlet, be sure the power is switched ON for proper remote operation.

Direct wiring the power supply

- **WARNING:** Disconnect power by unplugging the power cord or turning off the circuit breaker before removing the power supply end caps.
- **WARNING:** Do not use standard 120-volt AC dimmers with this power supply. Only use the integrated RF dimmer supplied with this kit.
- **IMPORTANT:** All wiring must be in accordance with national and local electrical codes, low-voltage Class 2 circuit. If you are unclear as to how to install and wire this product, consult a qualified professional.
- When the power supply end caps are removed, the input and output cables can be removed by loosening the screws on the power supply cable connector terminal block.

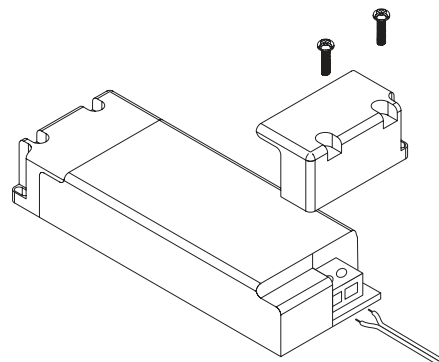

- Removing the low-voltage output cable from the power supply will allow cable runs through cabinets and around any obstacles as needed for a more custom installation. When reinstalling the cables to the power supply, be sure to follow the polarity printed on the case (white wire to +, gray to -).

- To direct wire, remove the AC input cable/plug and connect black live wire from a branch circuit to the line side (L) of the built-in terminal block and connect the white neutral wire to the neutral side of the terminal block (N), as indicated on the case. This LED power supply uses Class II AC inputs with a fully isolated case; ground wire should not be connected.
- Before restoring power, make sure all connections are tight and the endcaps are reinstalled securely.
- The 24-volt power cable to the tape lighting can be shortened or lengthened as needed. 18AWG is recommended when lengthening this cable; keep wire runs as short as possible. Always use suitable wire connectors to meet installation requirements.
- Use the optional screw-tabs for mounting securely when needed, for example, underneath a kitchen cabinet.

MOUNTING OPTIONS

- To surface mount the LED tape light under a set of cabinets in one continuous run, you may need to drill a 1/2 in. hole through any cabinet side lip that may be present. Install LED tape light through the hole and surface mount as a continuous run.
- For maximum light output and to focus light on the work surface, mount the tape light 1-2 inches behind the front cabinet lip. This mounting position works best with dull or matte finished countertops.

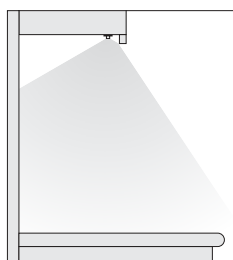

The LED tape has a wide beam angle

- To eliminate bright spots from highly reflective countertops, mount the tape light on the inside back of the cabinet lip frame facing towards your backsplash. Because of the wide beam angle of the tape light, this mounting position will still provide ample lighting.

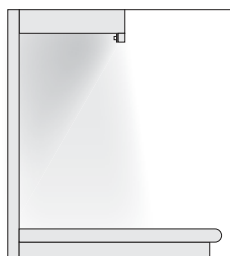

Mount on inside of cabinet lip to reduce reflections

- When mounting under a cabinet or a shelf with no lip to hide the LED tape light strip, create a visual barrier using a piece of quarter round molding or any angle trim to hide the LEDs.



Creating above cabinet uplighting

- Most cabinet tops have uneven surfaces. To create indirect uplighting over cabinets, simply mount the LED tape on any rigid strip (e.g., thin lattice or corner guard molding) and place on top of cabinets. Angle the strip position to achieve the desired illumination.

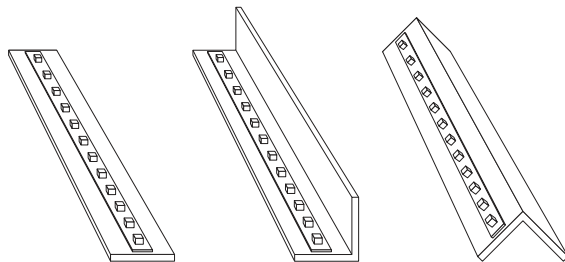

- For a seamless glow and to avoid bright light spots, move the LED tape light strip further from adjacent walls.

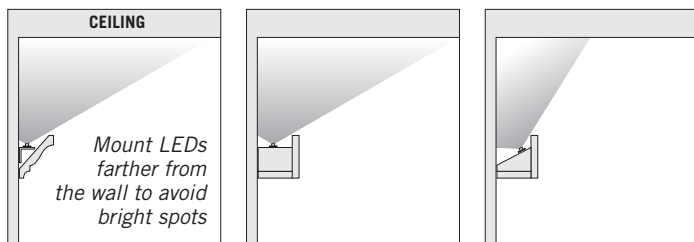

OPERATION

Functions of the remote

- Pull out the plastic battery barrier sheet from the battery compartment located on the bottom of the remote.
- The remote does not require line-of-sight to operate the lights. Range will vary depending on your building structure and where the receiver on the tape light is mounted.
- The remote can operate up to 50 feet in optimal conditions, but each installation has unique variables that may affect range.

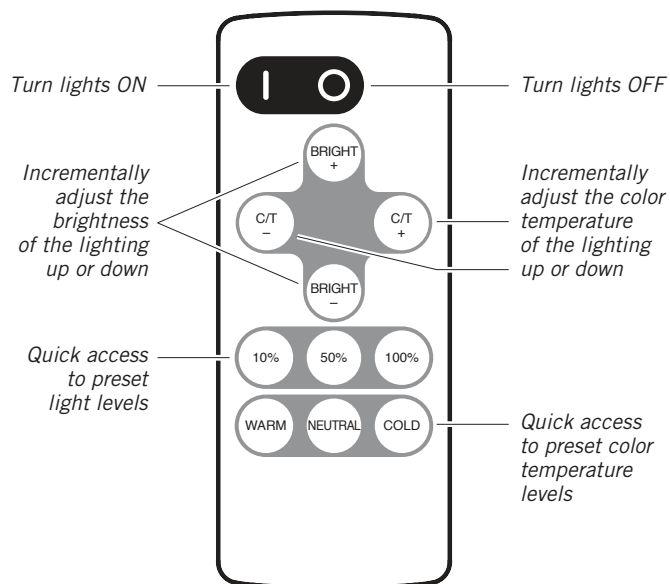

Pairing multiple kits

The remote in each kit comes paired with the tape light. For larger installations, multiple kits can be paired together for control by a single remote.

PAIRING

- Unplug the power supply for the kit that is to be paired. Wait 5 seconds
- Restore power to the power supply, then within 10 seconds press and hold the C/T – and the C/T + buttons on the remote at the same time
- The lights will flash to indicate a successful pairing. This kit will now operate with the remote used in this procedure. Repeat as desired with other kits and remotes.

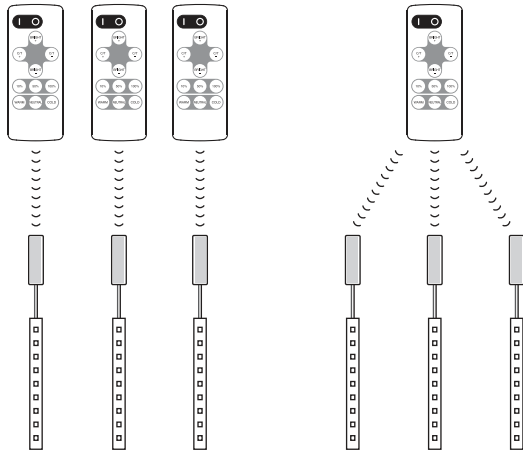

Each remote uniquely paired to a kit

One remote paired to multiple kits

TO RETURN TO SINGLE-REMOTE OPERATION

For each kit, perform the following steps using a unique remote:

- Unplug the power supply for the kit that is to be returned to single-remote operation.
- Restore power to the power supply, then within 10 seconds press and hold the C/T – and the C/T + buttons at the same time (The lights will flash to indicate the signal has been received)
- Perform the two steps above a second time to complete the process

This kit will now operate only using the remote used in this procedure. Repeat as desired with other kits and remotes.

Changing the Battery

- To replace the battery, pull the tray out of the remote. Refer to the instructions on the back of the remote.
- Always purchase the correct size and grade of battery that is most suitable for the intended use.
- Ensure the battery is installed correctly with regard to polarity (+ and –).
- Remove battery from the equipment when it is not being used for an extended period of time.
- Remove used batteries promptly.
- WARNING:** The remote contains a CR2032 DC 3V button battery. If swallowed, it could cause severe injury or death within 2 hours. Seek medical attention immediately.

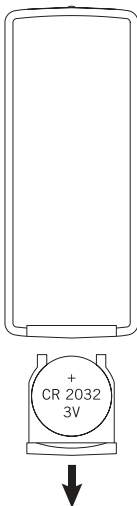

CARE AND CLEANING

- To clean the light, use a clean dry or slightly damp cloth.
- Do not use cleaners with chemicals, solvents or harsh abrasives as damage to the light strip may occur.

TROUBLESHOOTING

The LED strip will not light.

- The power supply does not have power.** Make sure the plug is fully inserted into a live 120-volt outlet. Check connections and circuit breaker if direct wiring.
- The power supply output cable is not properly secured.** Make sure that the DC output cable is wired securely to the output of the power supply.
- The polarity is incorrect.** Check that the orientation of the input and output match the markings on the case.
- Batteries in the remote are dead, improperly installed, or the battery protector has not been removed.** Make sure the battery protective strip is removed. Check that the orientation and type of battery are correct and that the battery is not depleted.
- The remote is too far from the receiver.** The remote can operate up to 50 feet in optimal conditions, but each installation has unique variables that may affect range.

Only part of the LED strip lights.

- A connection point is faulty.** Check for secure connections at the point that is not lit. Confirm that polarity is the same between the lit and unlit segments.

The fuse blows or a circuit breaker trips when the light is turned on.

- A wire is exposed.** Discontinue use of the lamp. Unplug the unit from the wall. Contact a qualified electrician.

FCC STATEMENT

This device complies with part 15 of the FCC Rules. Operation is subject to the following two conditions:

- (1) This device may not cause harmful interference, and
- (2) this device must accept any interference received, including interference that may cause undesired operation.

CAUTION: Any changes or modifications not expressly approved by the party responsible for compliance could void the user's authority to operate the equipment.

NOTE: This equipment has been tested and found to comply with the limits for a Class B digital device, pursuant to part 15 of the FCC Rules. These limits are designed to provide reasonable protection against harmful interference in a residential installation. This equipment generates, uses and can radiate radio frequency energy and, if not installed and used in accordance with the instructions, may cause harmful interference to radio communications. However, there is no guarantee that interference will not occur in a particular installation. If this equipment does cause harmful interference to radio or television reception, which can be determined by turning the equipment off and on, the user is encouraged to try to correct the interference by one or more of the following measures:

- Reorient or relocate the receiving antenna.
- Increase the separation between the equipment and receiver.
- Connect the equipment into an outlet on a circuit different from that to which the receiver is connected.
- Consult the dealer or an experienced radio/TV technician for help.

CUSTOMER SUPPORT

Email: support@armacostlighting.com | Phone: 410-354-6000

Monday–Friday, 9 a.m.–5 p.m., EST

Armacost
LIGHTING



SP
C 254684
Conforms to UL
Standard 8750

american
lighting
association

Baltimore, Maryland

armacostlighting.com

© 2019 Armacost Lighting. All rights reserved.

191101